

### English Language Arts (ELA) Program

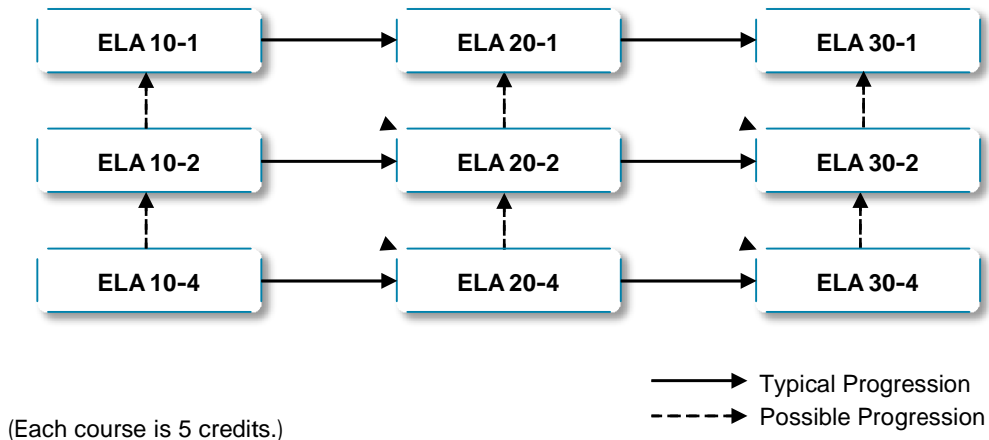

### Français Program (Francophone Schools)

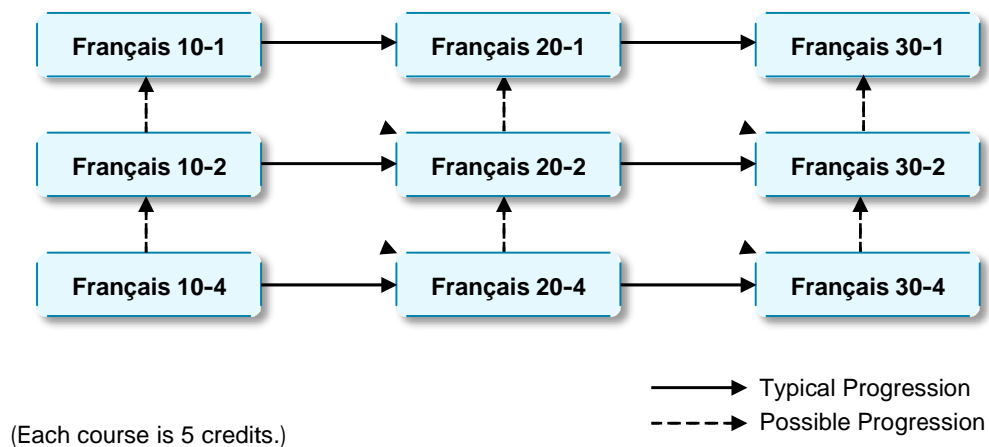

**Note:** Students generally take the prerequisite in a course sequence (e.g., English Language Arts 10-1, 20-1, 30-1). This route is designated by solid arrows. However, Alberta Education recognizes that students may transfer between course sequences and these recommended routes are designated by broken arrows.

The school authority shall have a policy that clearly states the criteria to be met by a student who wishes to change program routes.

### French Language Arts Program (French Immersion Schools)

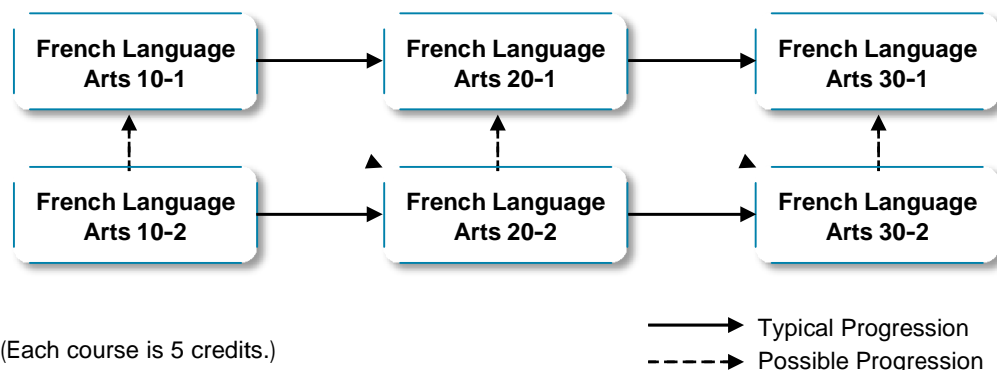

### French as a Second Language Course Sequences

(Note: All courses in each sequence below are 5 credits.)

For students in senior high school with no previous knowledge of French:

**French 10-3Y** —> **French 20-3Y** —> **French 30-3Y**

For students studying French with the requisite skills from the Grade 9 nine-year (9Y) course sequence:

**French 10-9Y** —> **French 20-9Y** —> **French 30-9Y**

For students who possess a superior level of French prior to entering Grade 10:

**French 31a** —> **French 31b** —> **French 31c**

This course sequence is intended for students who demonstrate language skills that are equivalent or superior to those demonstrated by students who have successfully completed French 30-9Y, and who desire to continue to refine their skills in French. Note that waived prerequisite credits for French 10, French 20 and French 30 are no longer available.

**Note:** Students generally take the prerequisite in a course sequence (e.g., English Language Arts 10-1, 20-1, 30-1). This route is designated by solid arrows. However, Alberta Education recognizes that students may transfer between course sequences and these recommended routes are designated by broken arrows.

The school authority shall have a policy that clearly states the criteria to be met by a student who wishes to change program routes.

### Mathematics Program

#### Possible Sequences—Mathematics Course Sequences

For students registered in Grade 10 since September 2010

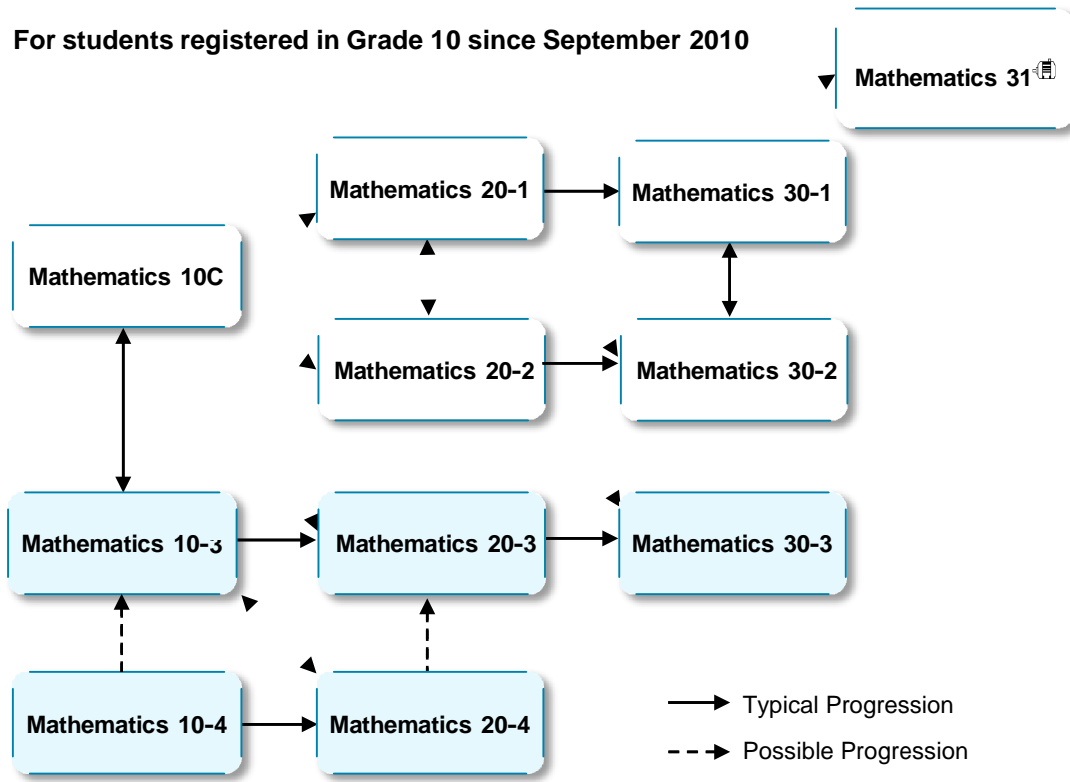

(Each course is 5 credits.)

📄 Mathematics 30-1 is a prerequisite or corequisite for Mathematics 31.

**Note:** Students generally take the prerequisite in a course sequence (e.g., English Language Arts 10-1, 20-1, 30-1). This route is designated by solid arrows. However, Alberta Education recognizes that students may transfer between course sequences and these recommended routes are designated by broken arrows.

The school authority shall have a policy that clearly states the criteria to be met by a student who wishes to change program routes.

### Science Program

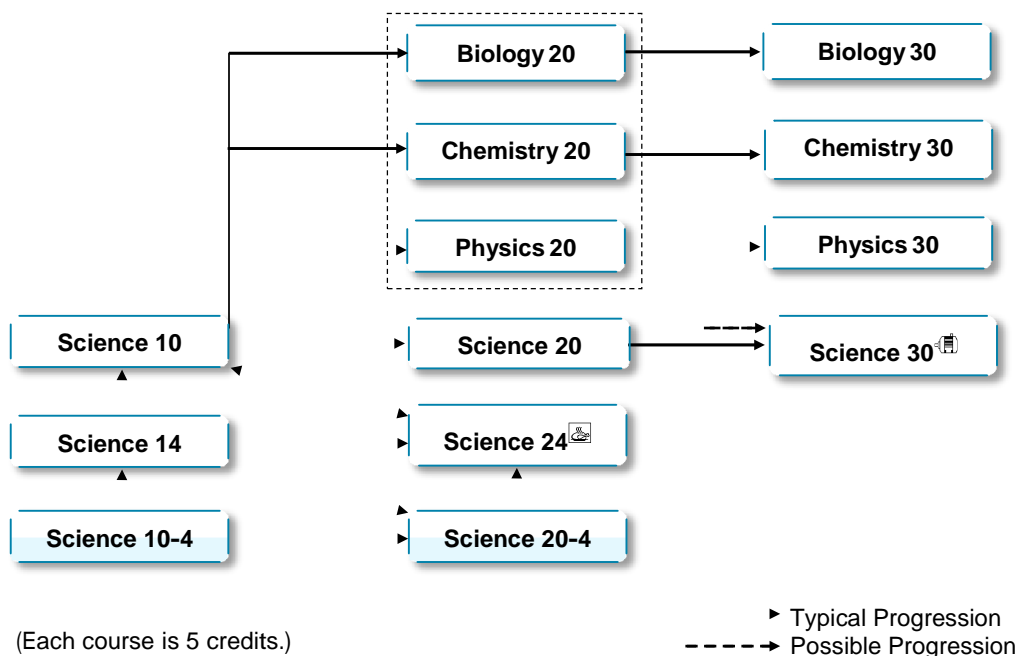

- 📖 Students who have achieved a final mark of 50% or greater in Biology 20, Chemistry 20, Physics 20 or Science 20 may enroll in Science 30.
- 📖 Although the recommended transfer point from Science 24 is to Science 10, in exceptional cases, students may be placed by the principal in 20-level courses, as serves the student's best interests.

### Social Studies Program

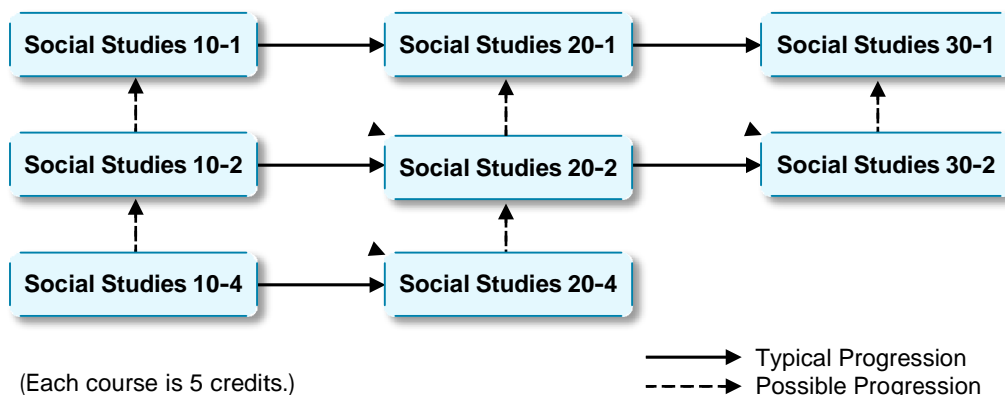

**Note:** Students generally take the prerequisite in a course sequence (e.g., English Language Arts 10-1, 20-1, 30-1). This route is designated by solid arrows. However, Alberta Education recognizes that students may transfer between course sequences and these recommended routes are designated by broken arrows.

The school authority shall have a policy that clearly states the criteria to be met by a student who wishes to change program routes.

## Knowledge and Employability Occupational Courses to Career and Technology Studies (CTS) Courses

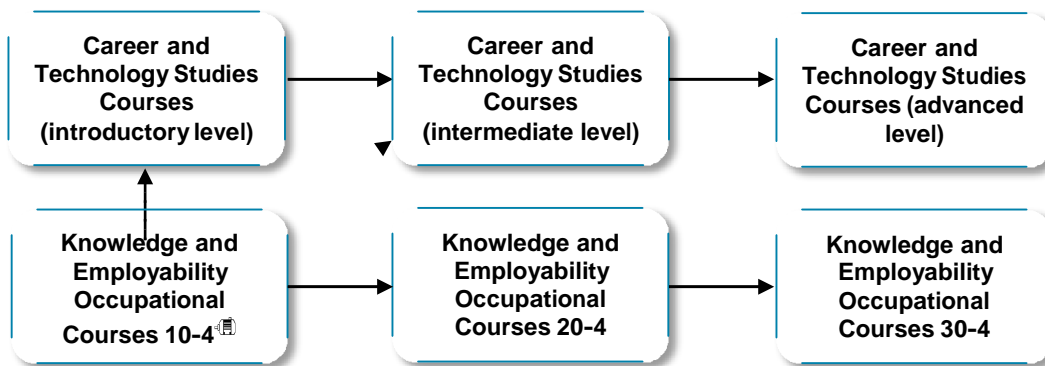

(Each CTS course is 1 credit.)

(Each Knowledge and Employability course is 5 credits.)

—————> Typical Progression  
 - - - - -> Possible Progression

- ☞ Transfer from a 10-4 Knowledge and Employability occupational course directly to an intermediate-level Career and Technology Studies course may be considered where there is content relevancy and prerequisite requirements are met.

For more information on Knowledge and Employability, see the [Knowledge and Employability Courses](#) section.

**Note:** Students generally take the prerequisite in a course sequence (e.g., English Language Arts 10-1, 20-1, 30-1). This route is designated by solid arrows. However, Alberta Education recognizes that students may transfer between course sequences and these recommended routes are designated by broken arrows.

The school authority shall have a policy that clearly states the criteria to be met by a student who wishes to change program routes.